



## Fuel Consumption and Emission Reduction in a Hybrid Electric Bus Through Peak Power Management of the Auxiliary Power Unit

Hosein Hamidi Rad<sup>1</sup>, Mohsen Esfahanian<sup>2\*</sup>, Saeed Behbahani<sup>3</sup>

<sup>1</sup> Department of Mechanical Engineering, Isfahan University of Technology, Isfahan, Iran

<sup>2</sup> Department of Mechanical Engineering, Isfahan University of Technology, Isfahan, Iran

<sup>3</sup> Department of Mechanical Engineering, Isfahan University of Technology, Isfahan, Iran

### ARTICLE INFO

#### Article history:

Received : 5 Jul 2023

Accepted: 20 Aug 2023

Published: 1 Sep 2023

#### Keywords:

Auxiliary power unit  
hybrid electric bus  
peak power management  
emissions  
fuel consumption  
fuzzy controller

### ABSTRACT

This study examines the impact of a fuzzy logic-based control strategy on managing peak power consumption in the auxiliary power unit (APU) of a hybrid electric bus. The APU comprises three components: an air compressor, a power steering system, and an air conditioning system (AC) connected to an electric motor. Initially, these components are simulated in MATLAB-SIMULINK software. While the first two are deemed dependent and independent of vehicle speed, respectively, the stochastic behavior of the steering is emulated using the Monte Carlo method. Subsequently, a fuzzy controller is designed and incorporated into the APU to prevent the simultaneous operation of the three accessories as much as possible. The results of repeated simulations demonstrate that the designed fuzzy controller effectively distributes the operation of the accessories throughout the driving cycle, thereby reducing overlaps in auxiliary loads. Consequently, the APU's average and maximum power consumption exhibit significant reductions. Furthermore, through multiple simulations with an upgraded power system model integrating the new APU-controller package, it is established that the proposed strategy for managing auxiliary loads in the bus leads to lower fuel consumption and emissions.

## 1. Introduction

The transportation industry has faced two significant challenges in recent decades [1]. Firstly, there has been a notable surge in the wasteful consumption of fossil fuels, leading to the depletion of a substantial portion of the world's oil reserves. Moreover, the detrimental impact of motor vehicles on air pollution and the environment has continued to worsen. Consequently, the automotive industry has shown

a growing concern for energy conservation and the reduction of emissions [2, 3, 4]. Notably, diesel engine vehicles play a disproportionate role in both oil consumption and greenhouse gas emissions. Despite constituting only 11% of the global motor vehicle fleet, they contribute to nearly half of the carbon dioxide emissions from vehicles and over two-thirds of particulate emissions [5].

\*Corresponding Author

Email Address: mesf1964@cc.iut.ac.ir  
<https://doi.org/10.22068/ase.2023.650>

Hybridization of vehicles has become a prominent strategy in the automotive industry to tackle fuel consumption and environmental challenges [6]. Hybrid electric vehicles (HEVs) provide the advantage of independently selecting the engine's operating point, regardless of the driver's torque request. As a result, hybridizing diesel-powered vehicles presents an opportunity to not only reduce fuel consumption but also potentially decrease pollutant emissions [7]. Nevertheless, even diesel hybrid electric vehicles (D-HEVs), which have demonstrated success in reducing particle mass (PM), still emit a notable quantity of particles in the low and medium size range [8]. Among various hybrid configurations, the diesel series hybrid electric vehicle (D-SHEV), mostly implemented in heavy duty commercial vehicles [5], stands out due to its ability to minimize particulate matter production by eliminating frequent and abrupt torque variations, as its diesel engine operates at a consistent velocity [9]. Nevertheless, concerns persist regarding other gaseous emissions, particularly nitrogen oxides (NO<sub>x</sub>), which account for 50% of diesel engine emissions, as well as hydrocarbons (HC) and carbon monoxide (CO) [5]. This raises the question of whether there are additional potential measures to enhance the fuel efficiency and environmental friendliness of such vehicles. In order to address this concern, it is important to take a closer look at the sources of power consumption in a vehicle.

In general, the loads on motor vehicles can be divided into two categories: road loads and auxiliary loads. Road loads encompass the resistant forces that a ground vehicle must overcome in order to move. These include rolling resistance force, aerodynamic resistance force, slope resistance force, and inertial force. On the other hand, auxiliary loads refer to the forces imposed on the vehicle by various accessories such as power steering, air compressor, air conditioner, lighting, lubrication, cooling, and more. In conventional vehicles, these loads are typically supported by the main (combustion) engine. To reduce these loads, different strategies are employed, and one of the most significant approaches is the implementation of an auxiliary power unit (APU). An APU is a device installed on a vehicle that supplies the power required by the accessories. Its purpose is to divert the auxiliary loads from the propulsion motor and provide them with power from a separate, smaller generator. This generator can take various forms, such as an electric motor, a small combustion engine, a microturbine, or a fuel cell.

APUs play a critical role in hybrid electric vehicles (HEVs) as they address the power requirements of auxiliary loads. In all configurations of HEVs, two primary power sources, typically an internal combustion engine (ICE) and a battery package, are utilized to provide propulsion across different operating conditions, including instances when the combustion engine is temporarily turned off. However, due to size limitations in producing either the battery package or the ICE, neither of them can reliably supply power to the auxiliary loads. As a result, HEVs incorporate an APU specifically designed to fulfill this role [10].

### 1.1. Literature review

Extensive research on auxiliary power units (APUs) has focused on effectively managing auxiliary loads in vehicles, especially hybrids. Studies fall into three main approaches: enhancing APU design, conducting field and lab tests, and utilizing simulation and control techniques. Notable research within these areas is discussed below:

Various studies have proposed control strategies to manage APUs in different vehicle configurations. Fingo et al. (2007) developed a field-oriented control (FOC) strategy for series-hybrid electric vehicles, ensuring steady-state and dynamic performance [10]. Demirsi et al. (2010) introduced an optimal sliding mode controller for the same setup, exhibiting high efficiency and minimal energy loss [11]. Feng et al. (2021) presented a robust multiple-input multiple-output (MIMO) control approach for series-hybrid electric vehicles, outperforming PID control in speed and torque synchronization [12]. Shuo Zhang et al. (2017) proposed an integrated management system for plug-in hybrid electric vehicles, showing significant fuel consumption improvement through model predictive control [13].

Beyond hybrid electric vehicles, APUs are utilized as range extenders in electric vehicles (EVs). Millo et al. (2012) successfully designed a powertrain controller for a range-extended EV, effectively minimizing carbon dioxide emissions while addressing noise concerns during APU operations [14]. Xiong et al. (2020) proposed a novel speed control strategy for engine speed in range extenders, enhancing system response and disturbance rejection capabilities [15]. Liu et al. (2021) introduced a fuzzy-PID control strategy for APU in range-extended EVs, improving overall

electrical control system performance and stability [16]. Wang et al. (2019) conducted a comprehensive study investigating five control strategies' impact on particulate emissions from the APU of a range-extended electric bus [8].

Heavy-duty vehicles benefit significantly from APUs due to their significant auxiliary loads. APUs offer an effective solution to address these loads [7]. However, in hybrid electric heavy-duty vehicles, the integration of APUs amplifies the complexity of managing auxiliary loads. In 2009, Murphy et al. proposed two power management strategies for a simulated Stryker truck model. One strategy aimed to achieve better fuel economy by setting target state of charges (SOCs) during driving and silent mode, while the other utilized a dynamic programming algorithm with an intelligent power controller (UMD-IPC) to optimize power flow for specific missions [17]. Despite the promising strategies, a limitation exists as the APU, responsible for supplying power to auxiliary loads and batteries during silent watch missions, remains inactive during driving. This limitation restricts the APU's full utilization throughout the mission, especially during periods of lower power demand. Enhancing APU utilization during driving presents an opportunity to further optimize efficiency and performance in heavy-duty vehicles.

In a 2004 study, Philippi et al. investigated fuel consumption in military FMTV trucks during silent watch mode, comparing two states: relying on propulsion alone and electrifying the accessories using a fuel cell auxiliary power unit (FC APU). Electrifying the accessories reduced total power consumption from 20.6 kW to 6.8 kW, with accessories operating at maximum efficiency [18]. Even when electrification is not feasible, another study by Najafian in 2012 examined the concept of reducing fuel consumption and emissions by only removing auxiliary loads from the main propulsion engine. He constructed an APU for a series-hybrid electric city bus, and simulated a simple model of this constructed APU, treating the three accessories as periodic loads, resulting in a significant reduction in fuel consumption and emissions of NO<sub>x</sub>, CO, and HC through periodic engagement and disengagement of accessories powered by the electric motor [19]. These findings highlight the potential benefits of efficiently managing auxiliary loads in vehicles to enhance energy efficiency and reduce emissions.

It is worth noting that the absence of particulate emissions in this study, and similar ones, is not

due to neglect but rather the complexity of this matter. Particle mass (PM) and particle number (PN) depend on various factors related to combustion conditions, such as fuel type, engine design, cylinder geometry, operating temperature, and more [20]. Additionally, special equipment and procedures are required for their measurement, as highlighted in reference [7, 8]. Therefore, these emissions cannot be simply attributed to the vehicle's velocity (driving cycle).

The present study tries to go a further step in the energy management of the Auxiliary loads. As observed, APUs, especially in heavy-duty vehicles, often consist of multiple accessories with different operation cycles. Whether electrified or not, there is still significant untapped potential for energy savings. In all of the mentioned studies, the APU is designed based on the worst-case scenario, where the power source capacity (electric motor, battery, fuel cell, etc.) is equal to or greater than the sum of the auxiliary loads. This accounts for the possibility that all accessories may need to operate simultaneously, although it is not very common. It is conceivable that implementing a control strategy to manage the accessories in a manner that avoids their simultaneous operation could serve as a potential solution to address this challenge. This concept served as the initial motivation for the present study to design a novel control strategy that provides intelligence and flexibility to the APU, enabling the scattering of accessory operation and avoiding simultaneous activation. The objective is not only to reduce the peak power consumption of the APU but also to decrease the fuel consumption and emissions of the vehicle. To the best of our knowledge, the present study is the first to introduce a control strategy that employs such an approach to reduce the peak power consumption of an APU.

## 1.2. Problem definition

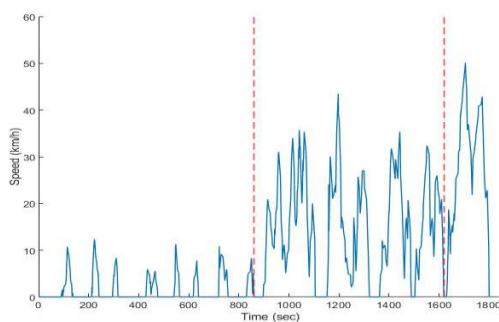
This study focuses on implementing a specific control strategy using MATLAB\_SIMULINK for the auxiliary power unit (APU) of a series hybrid electric bus [21]. The APU is designed for the Iran-Khodro O457 Diesel Bus, equipped with a 13-kW electric motor supplying power to three main accessories: an air compressor, a hydraulic pump, and a cooler compressor [19]. The goal is to minimize simultaneous accessory operation using a fuzzy controller, aiming to reduce peak

## Fuel Consumption and Emission Reduction in a Hybrid Electric Bus Through Peak Power Management of the Auxiliary Power Unit

power consumption, enhance energy efficiency, and lower emissions. The APU is initially modeled in MATLAB\_SIMULINK, and frequent simulations are conducted to evaluate the proposed control strategy's performance under real-world driving conditions, ensuring reliability and accuracy of the results. A comprehensive comparison is then made between the bus's performance with and without the control strategy to assess its effectiveness.

### 2. APU Modeling

To commence the simulation of a vehicle function, an essential step involves selecting an appropriate driving cycle [22]. This driving cycle acts as a speed profile that constrains the bus, allowing us to monitor the performance of both the bus and its accessories under standardized driving conditions. In this study, we have opted for the Tehran city urban bus driving cycle for this purpose. Tehran, the capital of Iran, is globally recognized as one of the largest and most densely populated metropolises. With approximately 8.5 million residents, the city's population surges to around 15 million during the day due to commuters from surrounding areas. As a result, the public transportation fleet plays a significant role in emissions production [23]. The selected driving cycle spans 1800 seconds and is divided into three distinct sections, representing congested, urban, and extra-urban scenarios [24]. Figure 1 visually depicts the Tehran driving cycle tailored specifically for urban buses.



**Figure 1:** Tehran driving cycle for the urban bus. Data taken from Ref. [24]

### 2.1. Compressor

The compressor's performance is simulated using the storage tank, making certain assumptions like isothermal process and avoiding the two-phase mode. The momentary tank pressure is calculated using the equation of state, flow rate equation, and relevant parameters, accurately modeling air compression [25].

$$PV = \frac{m}{M}RT \quad (1)$$

$$flow = rpm \times swept\ volume \quad (2)$$

The pressure loss cycle, which directly depends on the bus's velocity and moments of deceleration, is modeled based on the driving cycle. Moments of deceleration, accounting for 19.8% of the

$$P(kW) = \frac{Torque(N.m) \times speed(rpm)}{60/2\pi} \quad (3)$$

cycle's duration, contribute significantly to the pressure loss in the air compressor tank. The constant angular speed of the shaft at 2300 rpm is considered for calculating the power consumption of the air compressor.

Figure 1: Tehran driving cycle for the urban bus.

Data taken from Ref. [24]

#### 2.1.1. Governor design

The governor in the air compressor maintains the air pressure within the desired range of 6 to 8 bar. The model includes three switches, with one determining the tank status (filling or depleting) and the other two defining the upper and lower pressure bounds. This SIMULINK model of the air compressor is illustrated in Figure 2. It is worth noting that a similar governor, with minor value adjustments, can be used for the other two accessories as well.

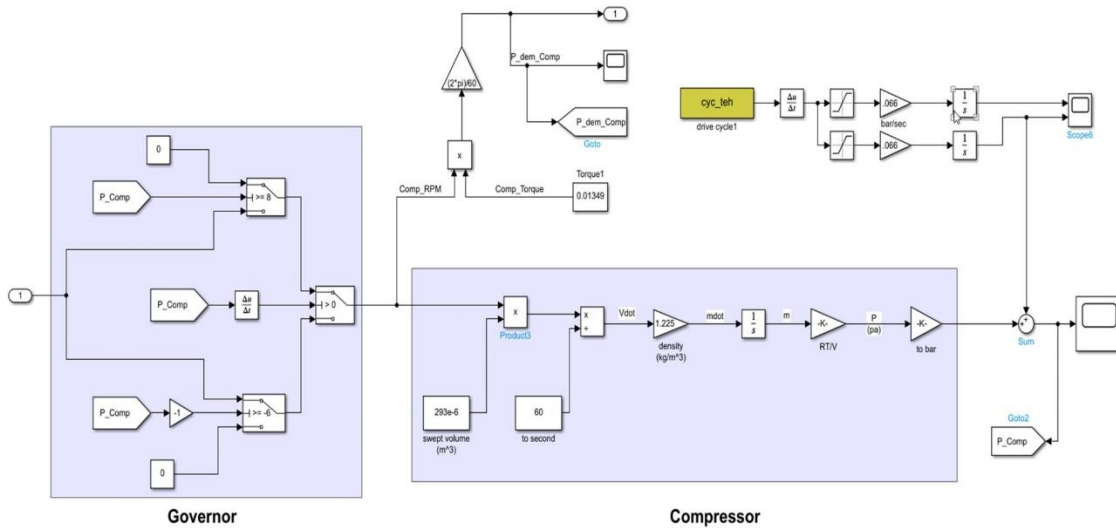


Figure 2: Final model of air compressor

### 2.1.2. Compressor simulation

Figures 3 and 4 display the simulation results for the air compressor's tank pressure and the power consumption of the compressor, respectively. It is evident that the governor effectively maintains the pressure within the desired range of 6-8 bar.

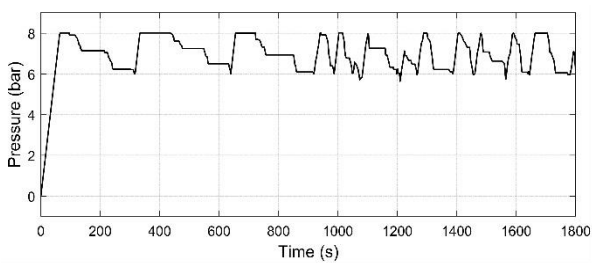


Figure 3: The pressure of the compressor

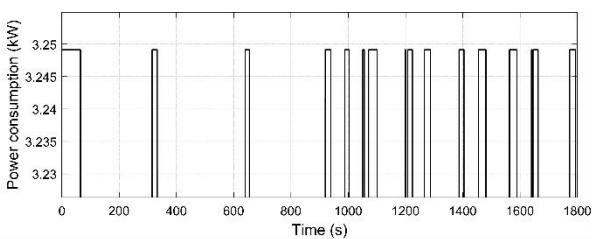


Figure 4: Power consumption of the compressor

### 2.2. Air conditioner

A simplified SIMULINK model of the 4 kW cooler compressor is developed to regulate the interior temperature of the bus. It starts from a

worst-case scenario of 45°C in the summer and aims to reach a comfortable temperature of 20°C within 3 minutes. A governor is implemented to maintain the temperature between 20-25°C. When the governor switches off the cooler compressor, the temperature takes 90 seconds to increase to 25°C. Conversely, when the cooler compressor is turned on again, the temperature returns to 20°C within 30 seconds. The AC model in SIMULINK, simulation results of the interior temperature, and AC power consumption are depicted in Figures 5, 6, and 7, respectively.

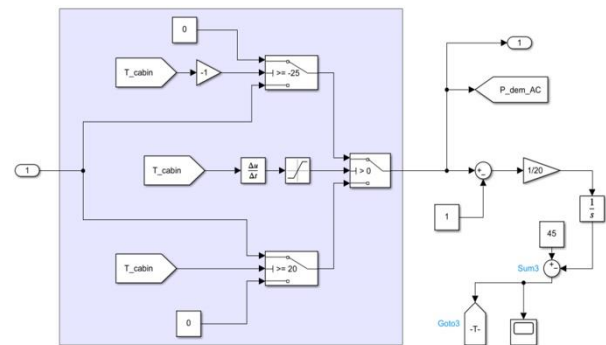


Figure 5: AC model designed in SIMULINK

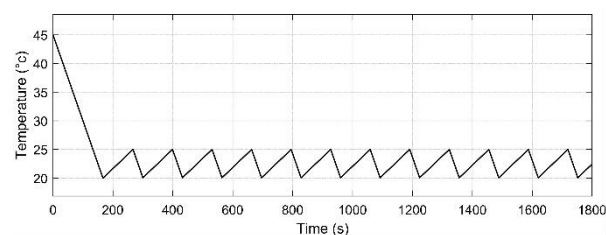


Figure 6: The interior temperature of the bus Regular)

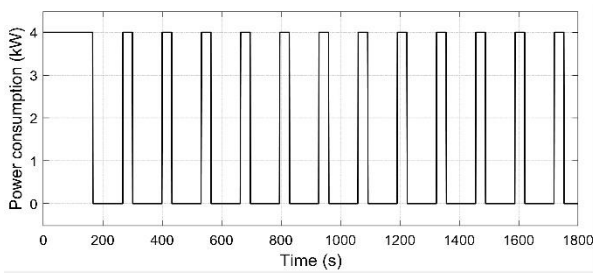


Figure 7: Power consumption of the AC

### 2.3. Power steering

In this study, we analyze the power steering system, focusing on a close-center type with an accumulator to store hydraulic pressure for multiple steering actions [26]. The system model accounts for the APU motor's speed (2300 rpm), which drives the hydraulic pump, rapidly increasing pressure. The accumulator stores sufficient pressure for up to ten steering actions. Unlike the air compressor tank's pressure loss, which depends on the driving cycle, modeling hydraulic pressure loss is challenging due to the power steering system's stochastic behavior. To address this, Monte Carlo analysis is employed to simulate real-world driving conditions comprehensively.

#### 2.3.1. Monte Carlo analysis

Monte Carlo simulation provides an alternative to analytical mathematics for understanding the statistical behavior of random samples. It involves drawing multiple random samples to approximate the frequency distribution and behavior [27], using either normal distributions or user-defined probability density functions (PDFs). The simulation is repeated multiple times to analyze the system's behavior [28]. In capturing the stochastic nature of bus steering, three significant inputs of the power steering system are considered as random: the number of steerings, the duration of each steering, and their placement. This variability allows for a comprehensive exploration of different scenarios. Table 1 presents the three random inputs of the power steering system and their corresponding values.

Table 1. Inputs to the power steering system

Input variable	distribution	Average	Standard deviation
Number of steering	Normal	130	20
Each steering duration (s)	Normal	2	1
Steering placement (Time axis)	Given	-	-

To generate a random number of steering events with varying lengths, we used a MATLAB script. To distribute these events randomly within the 1800 seconds driving cycle, we employed a probability distribution tailored for heavy-duty vehicles based on the study by Filipi et al. [18]. This PDF accurately represents the probability distribution of steering, considering the bus's motion and stops. As the vehicle starts moving, the probability of steering rapidly increases from zero, reaching its maximum value of one at a velocity of 11 km/h. As the vehicle accelerates, the probability of steering decreases and converges to zero at higher velocities. Figure 8 illustrates this probability distribution of steering in heavy-duty vehicles relative to their velocity.

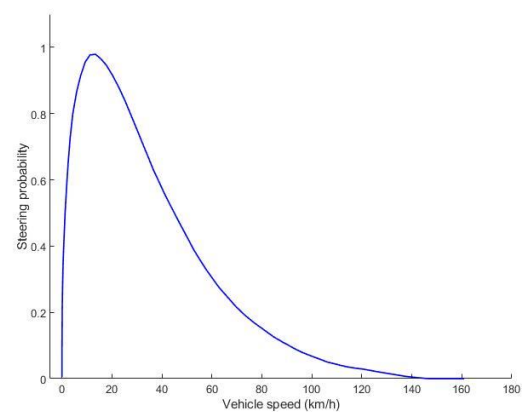
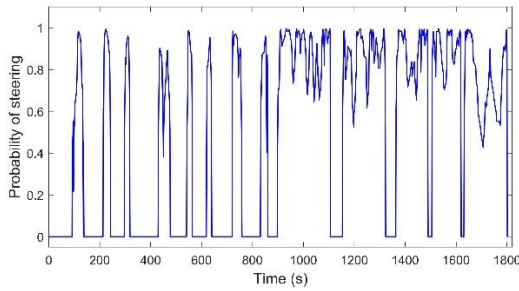


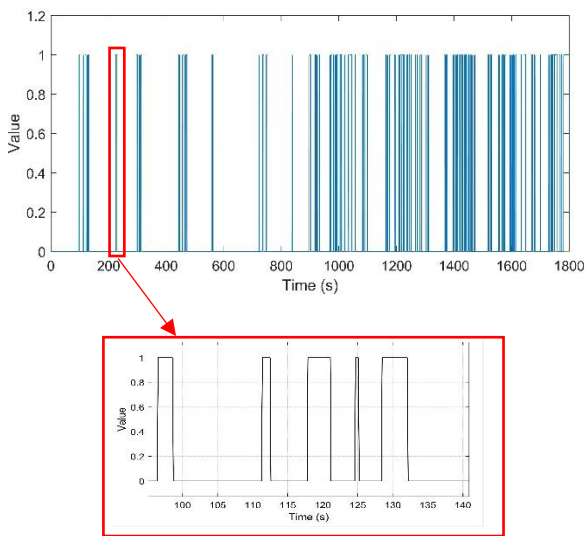
Figure 8: Probability distribution of heavy-duty vehicles according to their velocity. Data were taken from Ref. [18]

To determine the steering probability for each point in the Tehran driving cycle, we use a PDF and a lookup table based on the bus velocity. This allows us to establish the relationship between velocity and steering probability. Figure 9 illustrates the resulting PDF of steering probabilities.

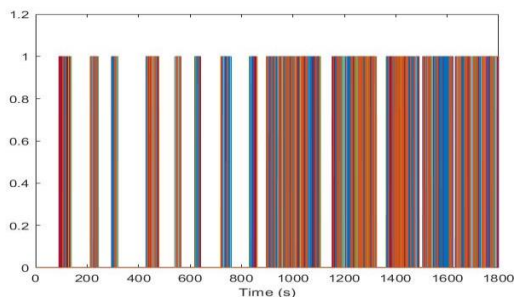


**Figure 9:** Probability distribution of the bus steering according to its speed

With the customized PDF, we generate a unique steering profile for each simulation run, allowing us to evaluate the APU controller's performance across multiple scenarios. Figure 10 shows a sample profile with 150 steerings, while Figure 11 illustrates 100 distinct steering profiles generated through the script. The steering points align well with the prescribed distribution, and as expected, there are no steerings at points with a probability of zero, corresponding to moments when the bus is stationary.



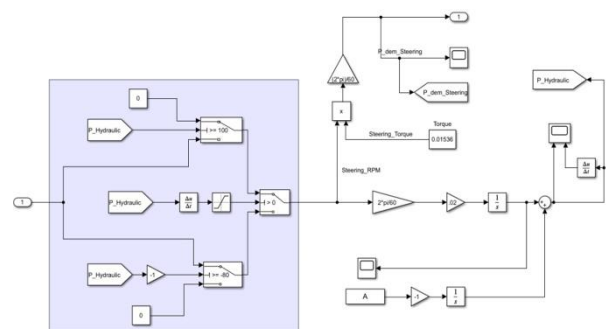
**Figure 10:** A sample of the bus's steering behavior with 150 steering



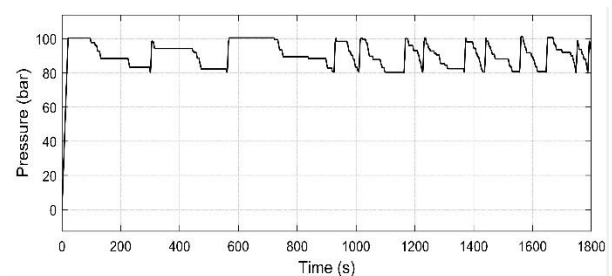
**Figure 11:** steering behavior after repeating 100 times

### 2.3.2. Power steering simulation

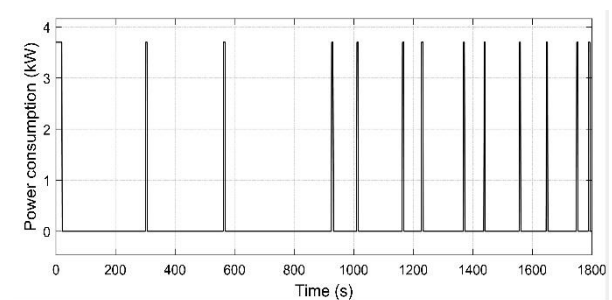
The pressure consumption cycle of the power steering system is integrated into the designed system as the pressure loss using a similar approach. By employing an integrator and equation (3) to calculate the power consumption, the final model is obtained. The uniqueness of each steering distribution leads to slight variations in the simulation results, mirroring real-world conditions. Figure 12 illustrates the final SIMULINK model of the power steering system. Figures 13 and 14 display the hydraulic pressure and power consumption, respectively, of the power steering system corresponding to the steering profile shown in Figure 10.



**Figure 12:** Final model of power steering



**Figure 13:** Hydraulic pressure of the power steering system



**Figure 14:** Power consumption of the power steering system

### 3. Controller design

A multi-input multi-output controller is necessary for the APU system, and existing rule-based controllers lack the desired flexibility due to their crisp input relations [8] [13]. To address this limitation, we employ a controller based on a Takagi-Sugeno fuzzy inference system (TS FIS). The fuzzy inputs allow for necessary flexibility, while explicit orders for engaging or disengaging accessories are required for the outputs. The controller takes three inputs: the tank pressure of the air compressor, the hydraulic pressure of the power steering system, and the interior temperature of the bus [8]. It generates three outputs, each representing a value between 0 and 1 for controlling the accessories. Each input is divided into three membership functions (MF) labeled as low, middle, and high. Figures 15, 16, and 17 depict these membership functions.

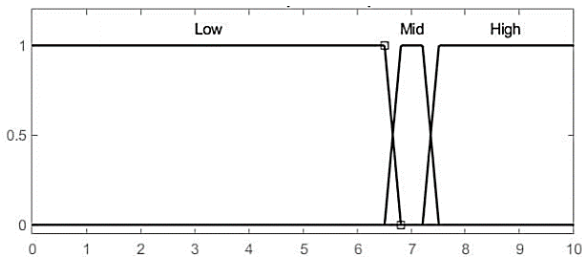


Figure 15: MFs of the air pressure of the compressor

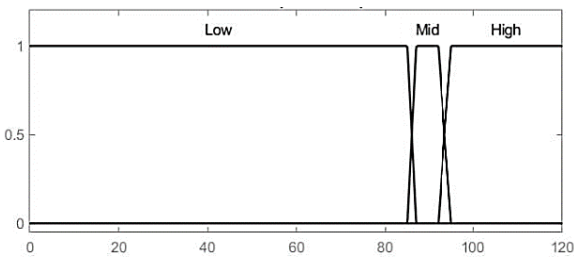


Figure 16: MFs of the hydraulic pressure in the power steering system

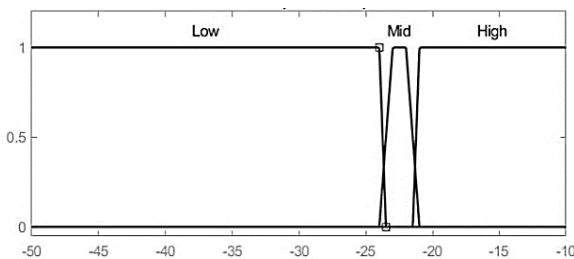


Figure 17: MFs of the interior temperature of the Bus

Based on the defined membership functions, 27 rules fine-tune accessory commands to minimize simultaneous operation. However, if all three accessories need to operate simultaneously, the air conditioning (AC) is given a lower priority than the air compressor and power steering system. This prioritization ensures critical functions are maintained, optimizing overall APU performance and resource allocation under heavy load.

An additional challenge with the TS fuzzy controller is the need for discrete turn-on or turn-off commands (0 or 1) for APU accessories, while the controller outputs continuous values (0 to 1). To overcome this, membership functions (MFs) are fine-tuned to make the outputs more explicit. A switch with a threshold of 0.5 is introduced to convert outputs below 0.5 to zero (turn-off) and above 0.5 to one (turn-on). Figure 18 shows the fuzzy controller outputs, and Figure 19 displays the final commands sent to the accessories.

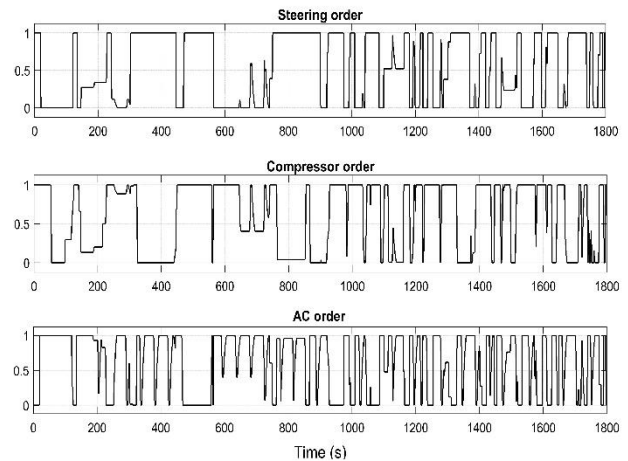


Figure 18: Outputs of the TS fuzzy controller

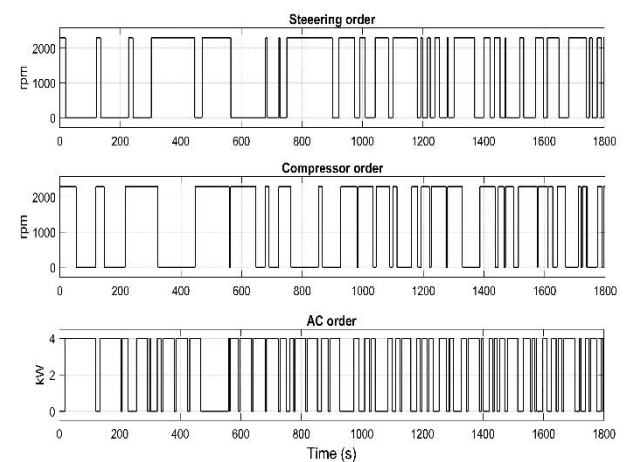


Figure 19: Final commands sent to the accessories

### 4. Final model

The final APU model results from combining individual models of the air compressor, power steering system, and air conditioning system. The power consumption of these accessories is summed to determine the APU's total power consumption. The model is then extended with the integration of the fuzzy controller to compare APU performance with and without the controller.

Additionally, the APU model with the controller is incorporated into the existing bus power system to analyze fuel consumption and emissions. Figure 20 depicts the final APU model, while Figure 21 illustrates the bus power system with the integrated APU model and fuzzy controller. This integration allowed for a comprehensive evaluation of the APU controller's impact on fuel consumption and emissions.

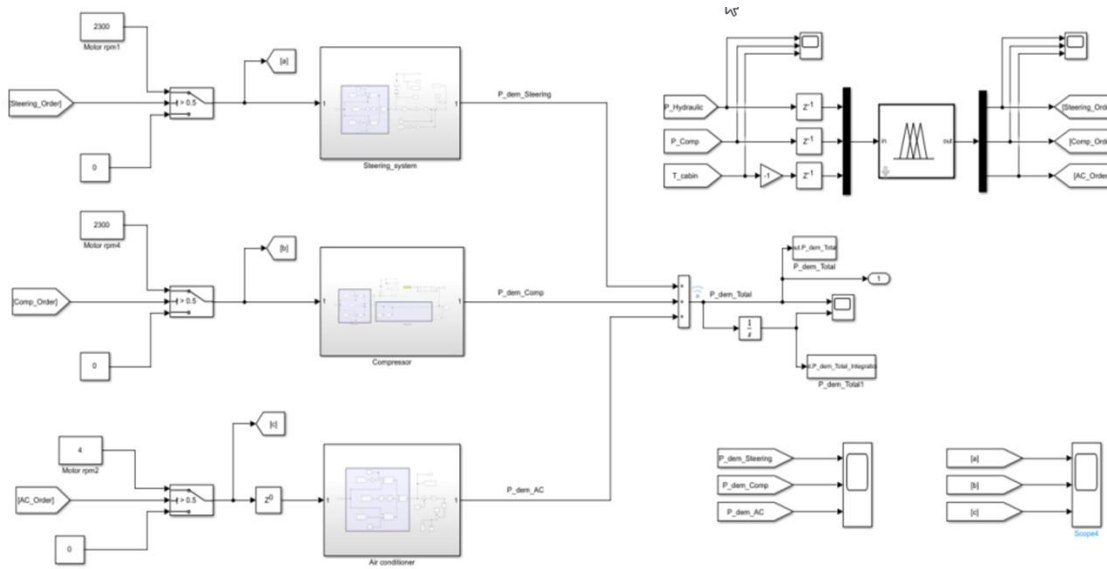


Figure 20: Final model of the APU in SIMULINK

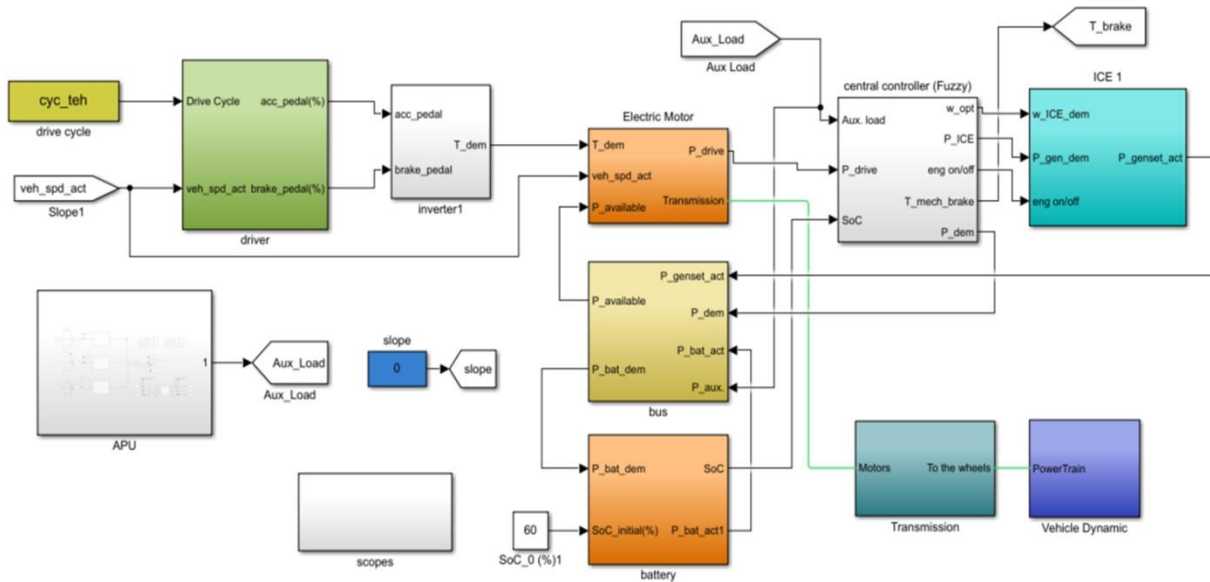
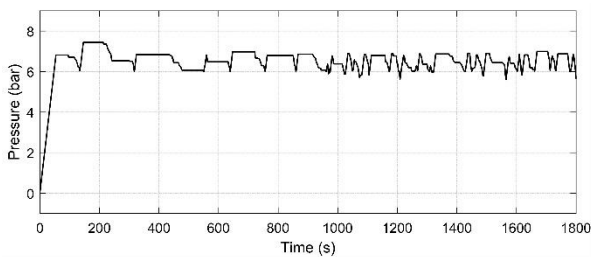


Figure 21: upgraded power system of the bus with APU-controller package in SIMULINK

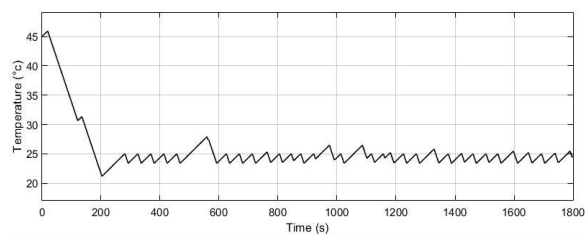
## 5. Simulation results and analyses

### 5.1. Accessories results

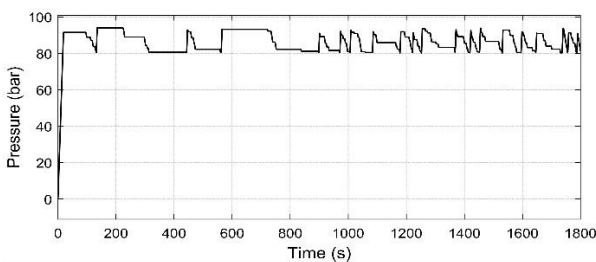
With the integration of the controller into the APU model, it becomes feasible to assess the impact of the control strategy on the performance of the accessories and the power consumption of the APU. Figures 22, 23, and 24 individually illustrate the effects of the control strategy on each accessory based on the sample simulation with 150 steerings.



**Figure 22:** Air pressure in the compressor tank with the presence of the controller



**Figure 23:** The interior temperature of the bus with the presence of the controller

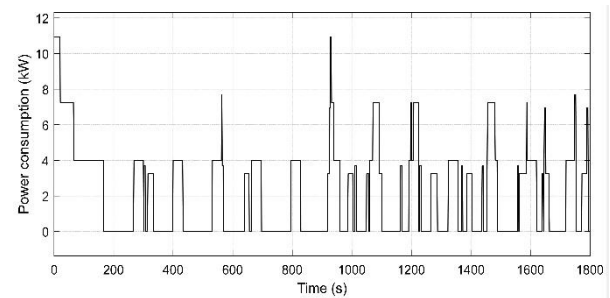


**Figure 24:** Hydraulic pressure of the power steering system with the presence of the controller

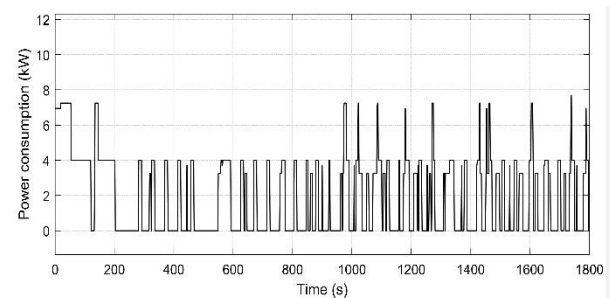
The figures clearly demonstrate the controller's ability to avoid simultaneous operation of the accessories by employing shorter on-off cycles. Despite the slight deviations from the comfort temperature range due to the AC's lower priority, the controller effectively maintains the temperature within an acceptable range.

### 5.2. APU and bus results

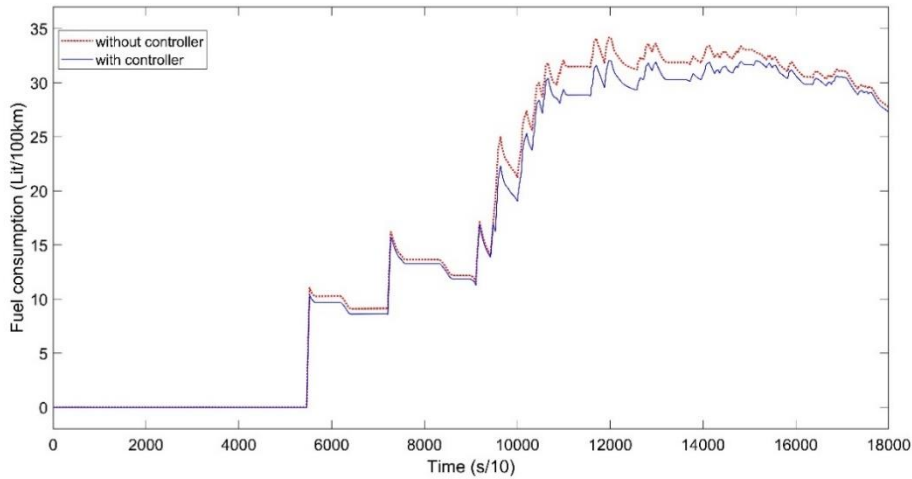
Figures 25 and 26 present a comparison of the APU's maximum power consumption in a sample simulation with 150 steerings, both with and without the presence of the controller. This comparison illustrates the controller's effectiveness in limiting the simultaneous operation of all three accessories to a maximum of two. Notably, the controller significantly reduces the occurrence of extended periods with two accessories operating simultaneously, as well as the occurrence of gaps where no accessories are active. The impact of these changes in the APU's behavior is evident in figure 27, which compares the bus's fuel consumption under the same steering conditions with and without the controller, assuming an initial state of charge of 60%.



**Figure 25:** APU power consumption without the controller in a sample simulation with 150 steering



**Figure 26:** APU power consumption with the controller in a sample simulation with 150 steering

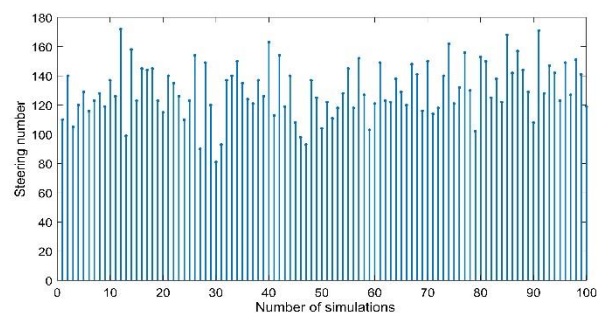


**Figure 27:** Comparison of bus fuel consumption with and without the presence of the APU controller in a sample simulation with 150 steering

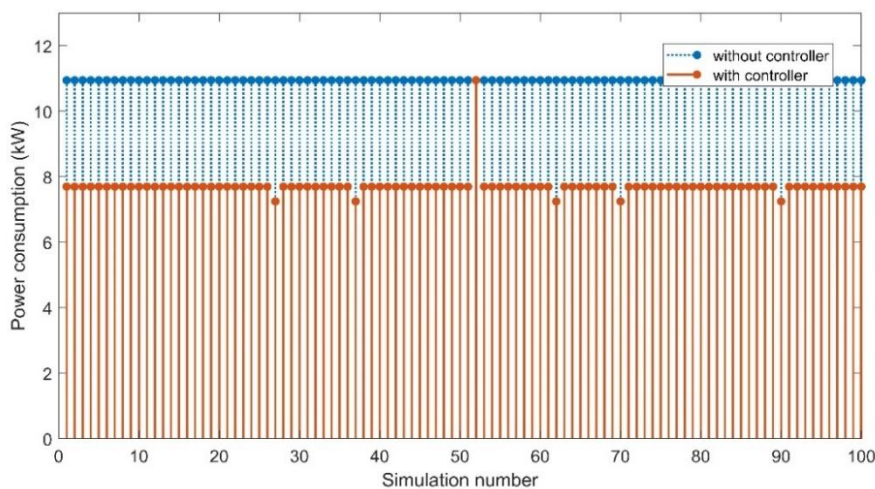
### 5.3. Monte Carlo results

As mentioned previously, due to the varying steering conditions in each simulation, it is necessary to repeat the simulation multiple times to assess the performance of the APU controller. Therefore, the APU simulation is repeated 100 times to obtain the results of the Monte Carlo analysis. Similarly, the general power system simulation of the bus, which is computationally intensive, is repeated 50 times. Figures 28, 29, and 30 display the results of these repeated simulations: the number of steerings in 100 simulations for the APU model, the maximum APU power consumption across 100 simulations,

and the average APU power consumption across 100 simulations, respectively.

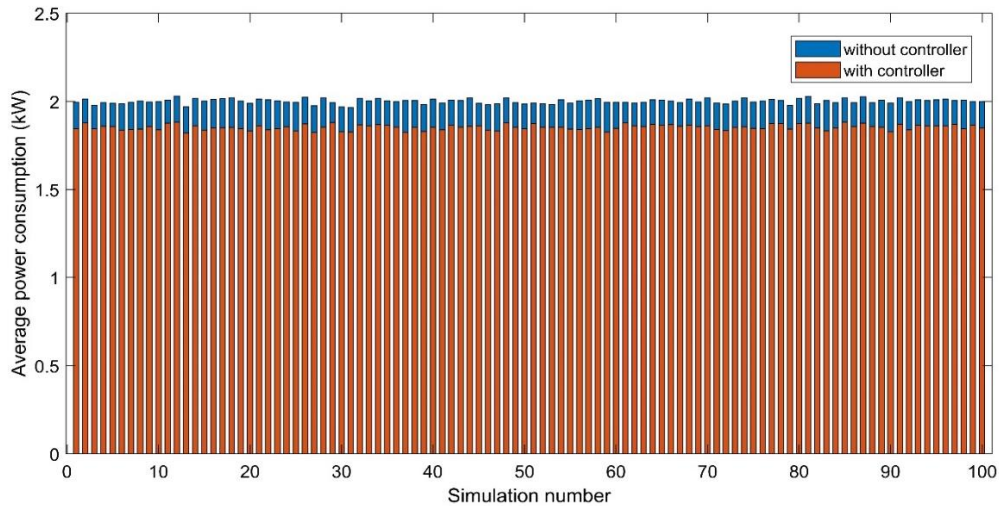


**Figure 28:** Number of steering in 100 simulations for the APU model



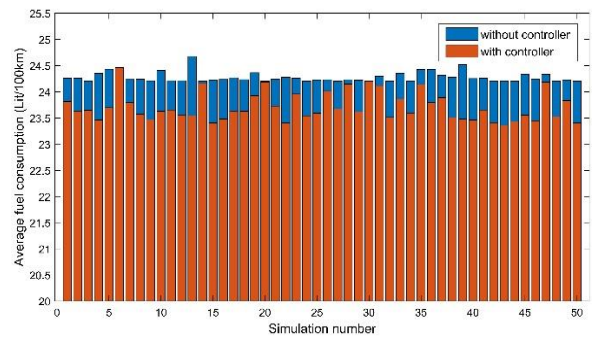
**Figure 29:** Maximum APU power consumption in 100 simulations

# Fuel Consumption and Emission Reduction in a Hybrid Electric Bus Through Peak Power Management of the Auxiliary Power Unit

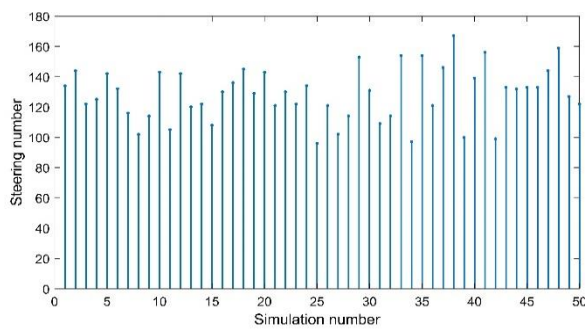


**Figure 30:** Average APU power consumption in 100simulations

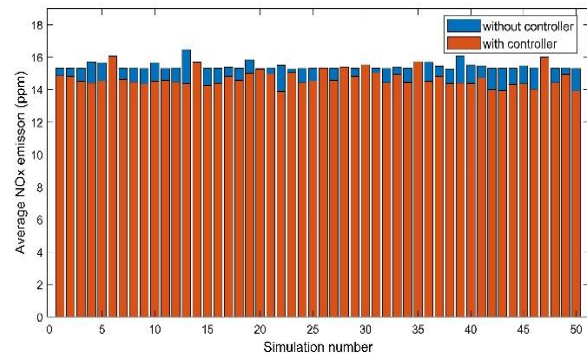
Figure 29 clearly demonstrates the effectiveness of the APU controller in reducing the simultaneous operation of all three accessories to just two accessories in 99% of the cases. This achievement aligns with the primary objective of the study. Additionally, Figure 30 reveals that the controller not only successfully reduces the peak power consumption of the APU but also yields an average decrease of 7.38% in the mean power consumption of the APU. These results highlight the significant impact of the controller on improving the overall power efficiency of the APU. Moving forward, the subsequent figures provide the Monte Carlo results for the bus.



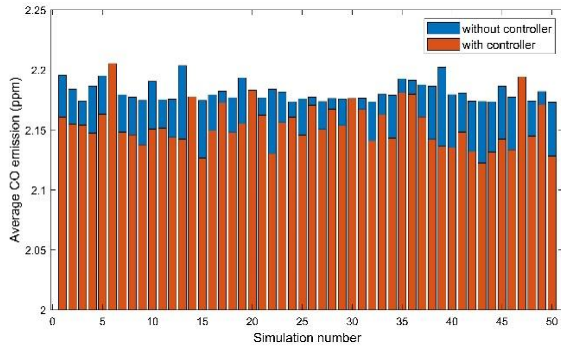
**Figure 32:** Average bus fuel consumption with and without APU controller in 50 simulations



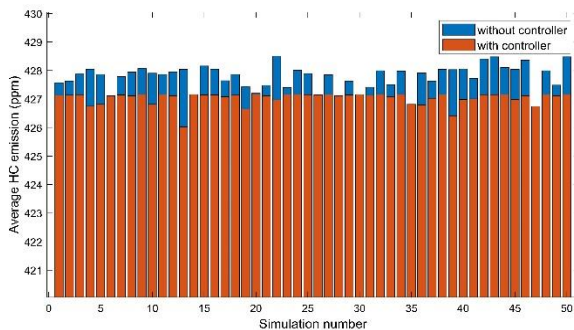
**Figure 31:** Number of steering in 50 simulations for the bus



**Figure 33:** Bus NOx emission with and without APU controller in 50 simulations



**Figure 34:** Bus CO emission with and without APU controller in 50 simulations



**Figure 31:** Bus HC emission with and without APU controller in 50 simulations

## 6. Discussion

In this study, we proposed a fuzzy logic-based control strategy for the APU of a hybrid electric bus to scatter accessory operations and minimize power demand overlaps. The APU package, including three sporadically operating accessories, was modeled with the fuzzy controller in MATLAB\_SIMULINK, using the Monte Carlo method for different steering conditions.

Simulation results showed the proposed fuzzy controller significantly reduced APU peak power consumption in nearly all cases, resulting in noteworthy reductions in bus fuel consumption and emissions. Table 2 summarizes the overall results, confirming the effectiveness of the APU controller in improving system performance.

**Table 2.** Overall results of the APU controller presence

Variable	Max. Reduction (%)	Mean. Reduction (%)
Ave. APU power cons.	8.98	7.38
Ave. fuel cons.	4.57	2.23
Ave. NOx emission	12.76	4.7
Ave. CO emission	3	1.24
Ave. HC emission	0.47	0.16

The results clearly demonstrate the significant impact of the well-designed control strategy for managing auxiliary loads and minimizing simultaneous accessory operation. The outcomes achieved are as follows:

1. The APU controller effectively prevents the simultaneous operation of the three accessories in 99% of cases, resulting in an average 7.38% reduction in APU power consumption. This reduction allows for the possibility of replacing the APU's current electric motor with a smaller and more cost-effective one (up to 67% reduction in current motor size), leading to reduced production costs for the APU system.

2. On average, the APU controller reduces bus fuel consumption by 2.23%. Given that auxiliary loads typically account for 8-10% of overall bus fuel consumption, this reduction translates to a significant 23-29% decrease in fuel consumption due to accessory operation.

3. The APU controller can handle the governor task, but both can be used in parallel for added precaution.

4. There is a noticeable reduction in bus gaseous emissions, and particulate emissions are also expected to be reduced. However, due to the complexity of particulate emissions' dependence on combustion conditions, their reduction might not be as prominent as the gaseous emissions.

## 7. Conclusion

In this study, we developed a MATLAB\_SIMULINK model to simulate the APU of a hybrid electric city bus. The model included an air compressor, power steering system, and air conditioning system. A Takagi-Sugeno fuzzy controller was employed to effectively manage these accessories and prevent their simultaneous operation. Inputs such as air compressor pressure, power steering system pressure, and bus cabin temperature were utilized to determine whether each accessory should be engaged at any given moment based on a set of rules. To capture the variability of the power steering system, the Monte Carlo method was incorporated, introducing random behavior influenced by the vehicle's speed profile. Multiple simulations using the driving cycle of Tehran city's urban bus were conducted to evaluate the control strategy's performance. The results demonstrated the effectiveness of the proposed control strategy in reducing the peak power consumption of the APU by allowing a maximum of two loads to operate simultaneously. This reduction in overlapping loads led to lower overall power consumption and emissions from the APU. To further advance this research and explore its practical applications, several avenues for future investigation emerge:

1. **Experimental Evaluation:** Future work may involve implementing the proposed control strategy in real auxiliary power units (APUs) of hybrid electric buses and conducting on-road experimental evaluations. This would provide valuable insights into the real-world performance and feasibility of the strategy.

2. **Road Tests:** Conducting Road tests on a larger scale, potentially involving a fleet of hybrid electric buses, could help assess the control strategy's effectiveness across various operating conditions and routes.

3. **Generalization to Other Platforms:** The strategy developed in this study can be extended to other types of APUs or platforms with accessories operating in non-specific cycles.

4. Investigating its adaptability to a broader range of systems could open up new possibilities for energy efficiency improvements.

5. **Emission Modeling:** Future research may delve deeper into the modeling of particulate emissions and their reduction, considering various combustion conditions and environmental factors.

## Declaration of Conflicting Interests

The author(s) declared no potential conflicts of interest with respect to the research, authorship, and/or publication of this article.

## References

- [1] Wang P, Li J, Yu Y, Xiong X, Zhao S, Shen W, Energy management of plug-in hybrid electric vehicle based on trip characteristic prediction. *Proceedings of the Institution of Mechanical Engineers, Part D: Journal of Automobile Engineering*, (2020), Jul;234(8):2239-59.
- [2] Tsanakas, N., Ekström, J. and Olstam, J., Generating virtual vehicle trajectories for the estimation of emissions and fuel consumption, *Transportation Research Part C: Emerging Technologies*, (2022), 138, p.103615.
- [3] Joshi, A., Review of vehicle engine efficiency and emissions, *SAE International Journal of Advances and Current Practices in Mobility*, (2022), 4.2022-01-0540, 1704-173.
- [4] Kodjak, D, Policies to reduce fuel consumption, air pollution, and carbon emissions from vehicles in G20 nations, *The International Council on Clean Transportation*, vol. 21, (2015).

- [5] Reşitoğlu, İ. A., Altinişik, K., & Keskin, A., The pollutant emissions from diesel-engine vehicles and exhaust aftertreatment systems, *Clean Technologies and Environmental Policy*, vol.17(1), (2015), pp.15-27.
- [6] Borthakur S, Subramanian SC., Design and optimization of a modified series hybrid electric vehicle powertrain, *Proceedings of the Institution of Mechanical Engineers, Part D: Journal of Automobile Engineering*, (2019), May;233(6):1419-35.
- [7] Nüesch, T., Wang, M., Isenegger, P., Onder, C. H., Steiner, R., Macri-Lassus, P., & Guzzella, L., Optimal energy management for a diesel hybrid electric vehicle considering transient PM and quasi-static NO<sub>x</sub> emissions, *Control Engineering Practice*, (2014), 29, 266-276.
- [8] Wang, Yaxin, et al., Comparison of Particulate Emissions of a Range Extended Electric Vehicle under Different Energy Management Strategies, (2019), No. 01-1189. SAE Technical Paper.
- [9] Tribioli L, Bella G., Reduction of particulate emissions in diesel hybrid electric vehicles with a PMP-based control strategy, *Energy Procedia*, (2018), Aug 1;148:994-1001.
- [10] Fiengo, G., Glielmo, L., & Vasca, F., Control of auxiliary power unit for hybrid electric vehicles, *IEEE transactions on control systems technology*, (2007), vol.15(6), pp.1122-1130.
- [11] Demirci, M., Biliroglu, A. Ö., Gökasan, M., & Bogosyan, S., "Sliding mode optimum control for APU of series hybrid electric vehicles.", In 2010 IEEE International Symposium on Industrial Electronics, pp. 340-345, 2010.
- [12] Feng, H., Ye, J., Xiong, W., Gong, Q. and Xu, J., Delay-dependent mimo robust control for power following system of auxiliary power unit in series hybrid electric vehicles, *IEEE Transactions on Vehicular Technology*, (2021), 70(5), pp.4353-4365.
- [13] Zhang, S., Xiong, R., & Sun, F., Model predictive control for power management in a plug-in hybrid electric vehicle with a hybrid energy storage system, *Applied Energy*, (2017), vol.185, pp.1654-1662, 2017.
- [14] Millo F, Rolando L, Mallamo F, Fuso R., Development of an optimal strategy for the energy management of a range-extended electric vehicle with additional noise, vibration and harshness constraints, *Proceedings of the Institution of Mechanical Engineers, Part D: Journal of Automobile Engineering*, (2013), Jan;227(1):4-16.
- [15] Xiong, W., Ye, J., Gong, Q., Feng, H., Xu, J., & Shen, A. , A range-extender engine speed control strategy with generator torque as an auxiliary input, *Control Engineering Practice*, (2020), 103, 104596.
- [16] Liu H, Lei Y, Fu Y, Li X., Optimization and realization on the coordination control strategy for auxiliary power unit of range-extended electric vehicle, *Proceedings of the Institution of Mechanical Engineers, Part D: Journal of Automobile Engineering*, (2022), Nov;236(13):2865-78.
- [17] Murphey, Y. L., Masrur, M. A., & Neumann, D. E., Exploring cognitive knowledge for intelligent vehicle power management in military mission scenarios, In NDIA ground vehicle Systems Engineering and Technology Symposium, (2009).
- [18] Filipi, Z., Louca, L., Stefanopoulou, A., Pukrushpan, J., Kittirungsi, B., & Peng, H., Fuel cell APU for silent watch and mild electrification of a medium tactical truck, *SAE transactions*, (2004), pp.1029-1043.

## Fuel Consumption and Emission Reduction in a Hybrid Electric Bus Through Peak Power Management of the Auxiliary Power Unit

- [19] Najafian, M., Design, Analysis and Simulation of Auxiliary Power Unit in the Hybrid Bus in Order to Reduce Fuel Consumption and Emissions , Department of mechanical engineering, Isfahan University of Technology, (In Farsi), (2012).
- [20] Gao, J., Ma, C., Xing, S., Sun, L. and Huang, L., A review of fundamental factors affecting diesel PM oxidation behaviors, *Science China Technological Sciences*, 61(3), (2018), pp.330-345.
- [21] Esfahanian, M., et al. Matlab-based modeling, simulation, and design package for Electric, Hydraulic, and Flywheel hybrid powertrains of a city bus, *International Journal of Automotive Technology*, (2018), 15.6: 1001-1013.
- [22] Safaei A, Ha'iri-Yazdi MR, Esfahanian V, Esfahanian M, Masih Tehrani M, Nehzati H., Designing an intelligent control strategy for hybrid powertrains utilizing a fuzzy driving cycle identification agent, *Proceedings of the Institution of Mechanical Engineers, Part D: Journal of Automobile Engineering*, (2015), Aug;229(9):1169-88.
- [23] Vafa-Arani, H., Jahani, S., Dashti, H., Heydari, J., & Moazen, S, A system dynamics modeling for urban air pollution: A case study of Tehran, Iran, *Transportation Research Part D: Transport and Environment*, vol.31, (2014), pp.21-36.
- [24] Montazeri-Gh, M., Varasteh, H., & Naghizadeh, M., Driving cycle simulation for heavy duty engine emission evaluation and testing, *SAE transactions*, (2015), pp.1506-1524.
- [25] Bielić, T., Čulin, J., Poljak, I., & Orović, J., Causes of and Preventive Measures for Complacency as Viewed by Officers in Charge of the Engineering Watch, *Journal of Marine Science and Engineering*, vol.8(7), (2020), pp.517.
- [26] Yang, Z. J., He, Q. H., & Liu, B., Dynamic characteristics of hydraulic power steering system with accumulator in load-haul-dump vehicle., *Journal of Central South University of Technology*, vol.11(4), (2004), pp.451-456.
- [27] Sandrock, C., de Vaal, P., & Weightman, D., Performance comparison of controllers acting on a batch pulp digester using Monte Carlo modelling, *Control engineering practice*, (2006), 14(8), 949-958.
- [28] Anttila, J., Uncertainty in electric bus driving cycles, school of engineering, Altato university (Master's thesis), (2016).